

# **OWNER'S MANUAL**

1-888-662-7522 // [arklithium.com](http://arklithium.com) // [info@arklithium.com](mailto:info@arklithium.com)

# TABLE OF CONTENTS

UNPACKING YOUR BATTERY

**3**

WHAT'S INSIDE

**3**

BATTERY FEATURES

**4**

BATTERY SET-UP

**5**

MONITORING & USE

**6**

WARRANTY

**7**

TROUBLESHOOTING

**8**

CABLING GUIDE

**9**

RACKING ASSEMBLY GUIDE

**12**



## UNPACKING YOUR BATTERY

CAUTION: Battery crates may have sharp, protruding nails.

CAUTION: Battery should only be unpacked by qualified battery installers.

CAUTION: Do not penetrate, dump, or otherwise damage the battery crate prior to the removal of the battery. Abusing the battery in this manner will void the warranty.

CAUTION: Do not store the battery in extreme temperature environments or in direct sunlight.

CAUTION: Do not touch the + or - terminals. High voltage may cause injury or death.

## WHAT'S INSIDE

When unpacking your battery, check to make sure that your battery includes the following accessories:

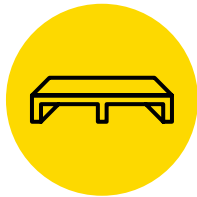

### FLANGE KIT

for vertical installation

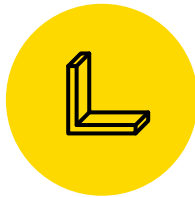

### ANGLE BRACKETS

for securing battery to wall (upright installation) or to top of cabinet (top battery only)

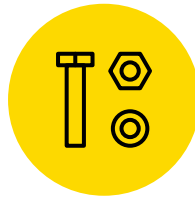

### HARDWARE PACKAGE

for cabinet installation

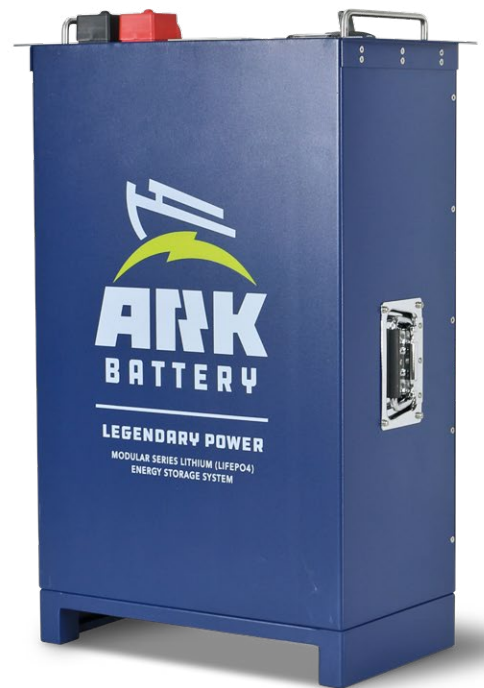

# BATTERY FEATURES

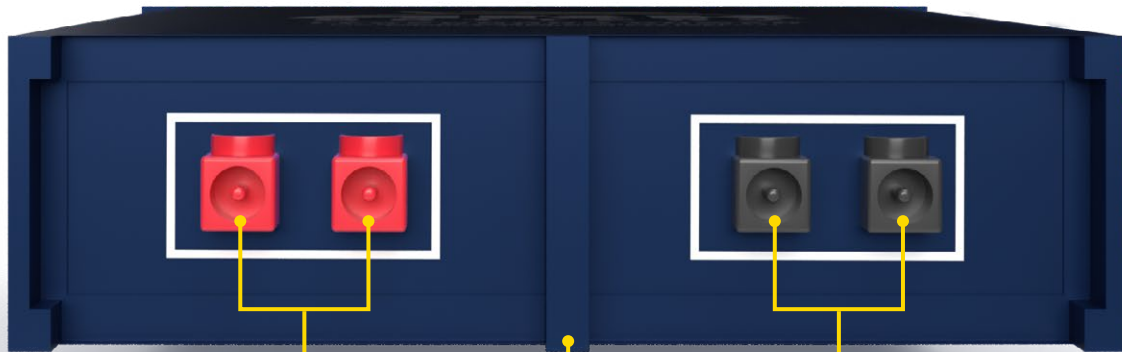

**POSITIVE  
TERMINALS**

**NEGATIVE  
TERMINALS**

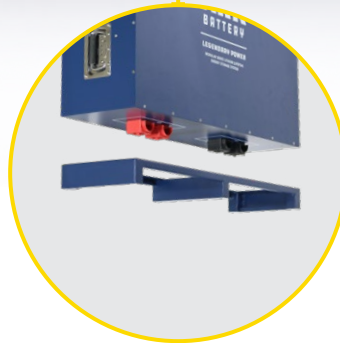

**DETACHABLE FLANGE KIT FOR  
UPRIGHT INSTALLATION**

# BATTERY SET-UP

## INSTALLATION

1. Ensure that the battery is firmly secured and will not move or tip. Batteries may be installed upright or horizontal in a cabinet. If installing horizontally without a cabinet, do not stack higher than three modules.
2. Cabling: leave all breakers in the 'off' position until cabling is completed. See cabling guide if connecting multiple batteries in parallel – page 11.
3. When paralleling multiple batteries, the maximum allowable voltage difference is 0.3 Volts. Charge or discharge batteries individually as needed before cabling them together.



CAUTION: Do not short-circuit + and - terminals.

CAUTION: Do not reverse polarity when connecting charging/ discharging equipment.

CAUTION: Do not install battery in an environment that is less than 32 degrees Fahrenheit or more than 120 degrees Fahrenheit.

CAUTION: ARK Lithium batteries should only be installed in dry, climate-controlled areas.

CAUTION: Do not connect batteries in series. Only parallel connections are permitted.



**NOTE:** An external main fuse or breaker is required when stacking 3 or more batteries in one bank. For single battery installations with no external fuse or breaker, a minimum wire/ cable size of 2 AWG copper is required. Follow NEC guidelines for cable sizing in banks that have multiple batteries paralleled.

**IMPORTANT!** When powering up an inverter system or any other type of load, set the breaker of each ARK battery in the bank to 'on' before installing/ turning on the main fuse or breaker. When powering down, disconnect the main fuse/ breaker before turning off breakers on the ARK batteries in your bank.

**NOTE:** Always keep cables as reasonably short as possible. Heavier cables should be used as necessary when compensating for distance between batteries and charge/discharge source. Avoid distances of more than 25 feet. It is not necessary to keep all cables exactly the same length.

Ensure that all charging and discharging equipment is programmed according to the specs – download our spec sheet at [arklithium.com](http://arklithium.com). An advanced setup guide for some inverters and charge controllers may be available for certified installers. Please contact your distributor to check availability.

# MONITORING & USE

ARK Batteries are equipped with a display for monitoring purposes. Calculations are made by means of an internal shunt. This display includes:

1. Battery volts
2. Charge/discharge amps
3. Charge/discharge watts
4. Time remaining
5. AH remaining
6. Charge indication (blinking backlight)
7. Discharge indication (solid backlight)

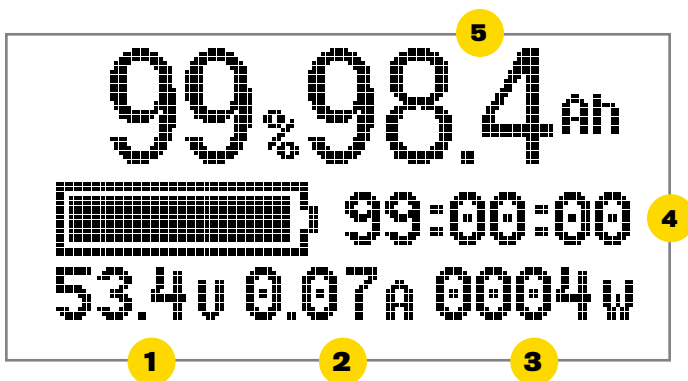

**NOTE:** The displayed percentage on a battery is not accurate until the battery has been fully charged. The meter will self-calibrate when full charge is reached.

To manually calibrate the meter on a new battery, charge battery to absorb voltage as outlined in the spec sheet. Maintain absorb voltage until charge current is less than 5% of battery capacity. Pressing and holding the 'up' (▲) button calibrates SOC% to 100%. Pressing and holding the 'down' (▼) button calibrates the battery to 0%.

There are no settings to be made on the meter!



# WARRANTY

## ARK BATTERY IS PLEASED TO OFFER A **5 YEAR WARRANTY** ON ALL PRODUCTS AND COMPONENTS.

Guarantee begins on date of installation.

### WARRANTY PROCEDURE

To obtain a warranty for a defective product, contact our support center at **888-662-7522**.

Only certified installers and distributors can claim a warranty. ARK Battery will issue an RMA for products deemed defective.

If product is deemed to be a cell-related issue, a replacement battery of equal or greater capacity will be sent to certified installer.

If defect is deemed to be a BMS or other electronics issue, ARK Battery, at its discretion will:

1. Ship a replacement battery of equal or greater capacity
- or**
2. Send a certified technician on site to replace the defective electronics.



**NOTE:** There is no warranty for batteries that are subjected to abuse including, but not limited to:

- Improper charging/discharging methods and/or settings (inverter)
- Hazardous voltages
- Excessive currents
- Temperature exposure outside of the guidelines on the spec sheet
- Unauthorized individuals opening the battery (broken seal)
- Cycles exceeding rated cycle life (see spec sheet)
- Improper cabling methods

# TROUBLESHOOTING

---

## **TROUBLE-SHOOTING AND/OR SERVICING AN ARK BATTERY SHOULD ONLY BE PERFORMED BY A QUALIFIED INDIVIDUAL.**

When calling for technical assistance, please have a DC voltmeter with a voltage range of 0-60vdc on hand.

<b>PROBLEM</b>	<b>CORRECTIVE ACTION</b>
<b>DISPLAY SCREEN IS BLANK</b>	<ol style="list-style-type: none"><li>1. Test for voltage on battery terminals with breaker in 'on' position. If no voltage is present, proceed to steps outlined in 'low-BMS cutout' below. If voltage is present, call for further assistance.</li><li>2. Ensure that battery temperature is above 32 degrees Fahrenheit.</li></ol>
<b>BMS LOW CUTOUT</b>	<p>Apply voltage to terminals to 'wake up' the battery.</p> <p>Caution: never 'jump' with another battery. Use a battery charger that performs within the specs outlined on page 7.</p> <p>We recommend the following chargers to wake up the battery:</p> <ul style="list-style-type: none"><li>• 24V: MEAN WELL GC120A24-AD1</li><li>• 48V: MEAN WELL GC120A48-AD1</li></ul> <p>Disconnect all charging/discharging sources until BMS has turned back on.</p>
<b>BMS HIGH VOLT CUTOUT</b>	Discharge battery until the charging portion of the BMS turns back on.
<b>PREMATURE BMS HIGH/LOW CUTOUT</b>	If the BMS shuts off during a charge cycle before reaching absorb voltage or shuts off during discharge before reaching 'recommended inverter low volt cutout' (page 6), call for further assistance.
<b>HIGH-PITCHED NOISE</b>	If battery maintains a consistent, high-pitched noise during charge or discharge call for further assistance.



# BATTERY CABLING GUIDE

**CAUTION: FAILURE TO FOLLOW PROPER CABLING PROCEDURE MAY LEAD TO INJURY OR DEATH!**

FIG 1.1

## 2 BATTERIES WITH CHARGE DISCHARGE <140A

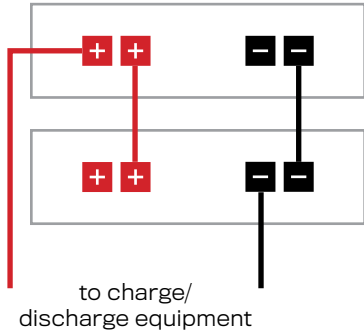

FIG 1.2

## 2 BATTERIES WITH CHARGE DISCHARGE 141-280A

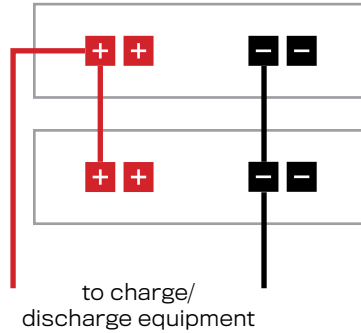
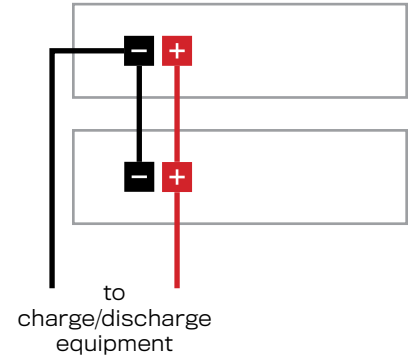

FIG 1.3

## 2 BATTERIES TOP/ FRONT CABLING



As of summer 2021, we will be including bidirectional terminal covers with every battery to accommodate two cables per terminal.

When paralleling multiple batteries, be sure to follow NEC guidelines for proper circuit protection. Use external breakers/fuses as needed to protect your cables.

Ensure that all battery breakers are in the "off" position when attaching cables.

FIG 1.4

## 3 BATTERIES WITH CHARGE/DISCHARGE CURRENT <140A

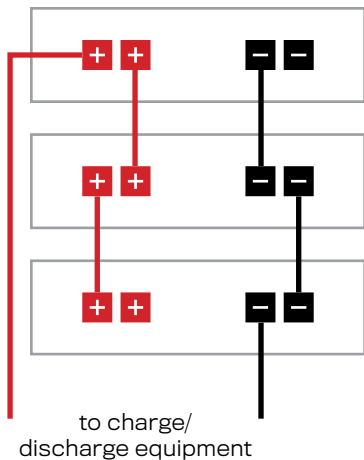

FIG 1.5

## 2 BATTERIES WITH CHARGE/DISCHARGE CURRENT 141-280A

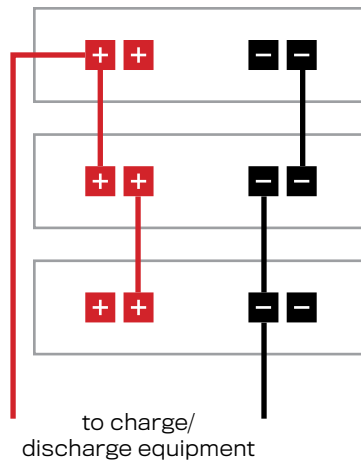
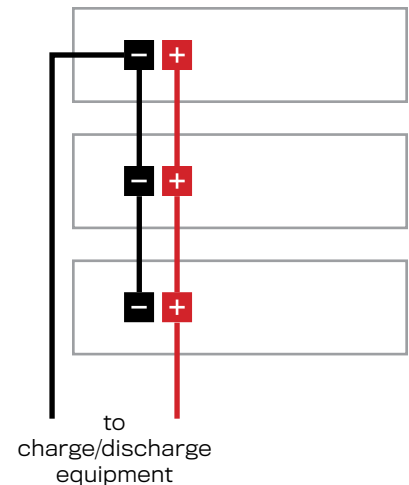

FIG 1.6

## 3 BATTERIES TOP/ FRONT CABLING



If you do not see your battery bank size or layout in this cabling guide, please contact us for a customized solution.

NOTE: Terminals are rated at 140A max. Overloading the terminals/improper cabling methods will void the warranty.

FIG 1.7

**3 BATTERIES WITH CHARGE/DISCHARGE CURRENT >280A**

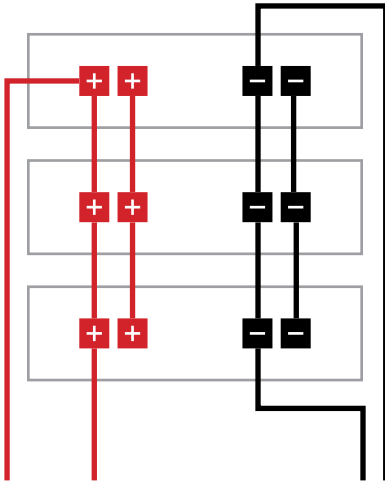

FIG 1.8

**4 OR MORE BATTERIES WITH CHARGE/DISCHARGE CURRENT <140A**

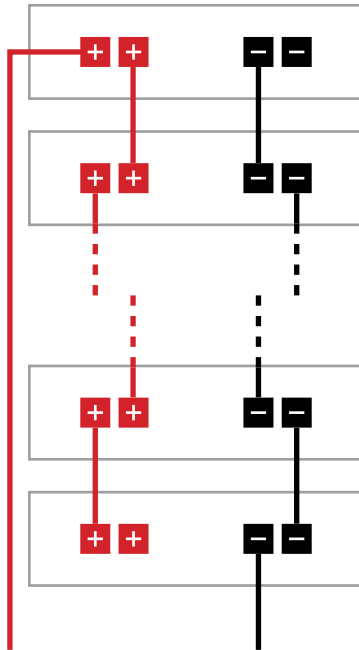

FIG 1.9

**4 OR MORE BATTERIES WITH CHARGE/DISCHARGE CURRENT 141-280A**

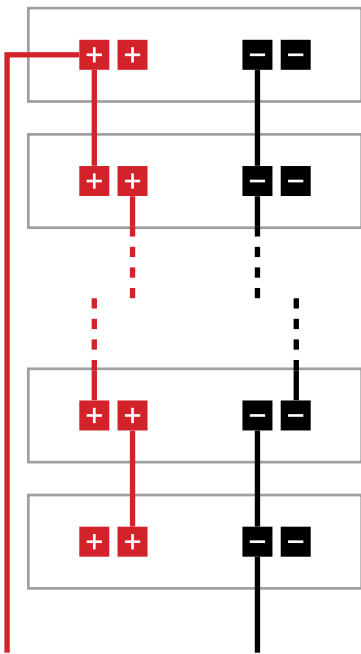

FIG 2.0

**4 BATTERIES WITH CHARGE/DISCHARGE >280A**

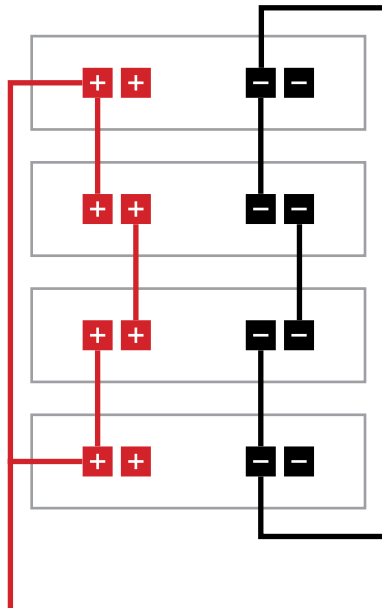

FIG 2.1

**5 BATTERIES WITH CHARGE/DISCHARGE >280A**

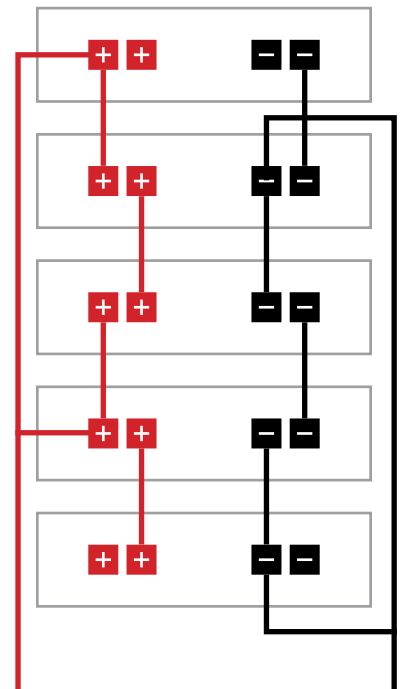

FIG 2.2

**6 BATTERIES WITH CHARGE/  
DISCHARGE 280-560A**

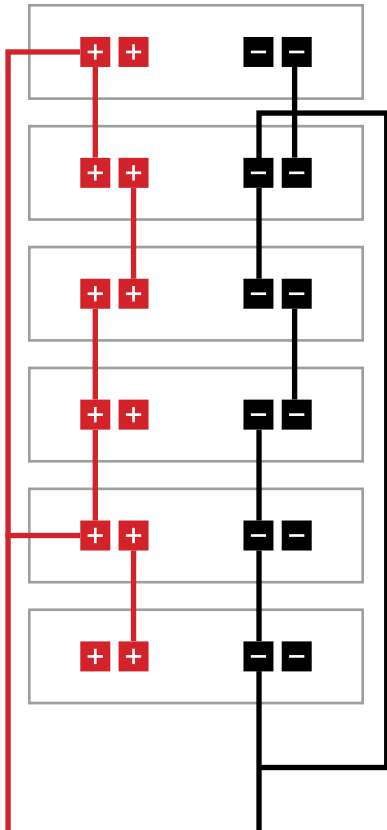
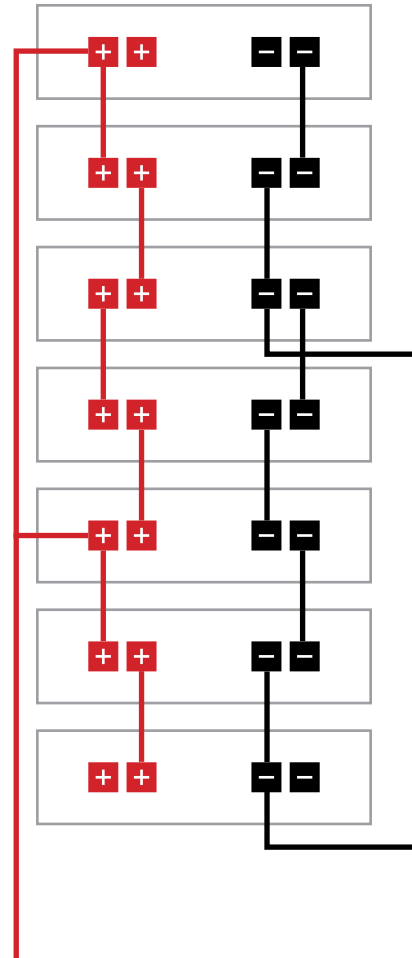
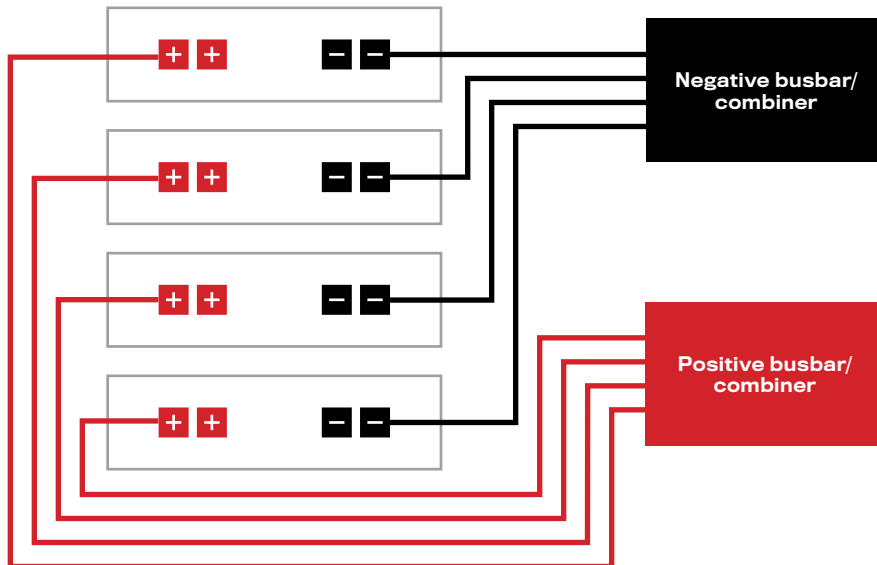

FIG 2.3

**7 BATTERIES WITH CHARGE/  
DISCHARGE CURRENT 280-560A**



**ALTERNATIVE CABLING METHOD**



Each battery may be cabled separatelt to an external busbar/combiner.

# ARK RACKING ASSEMBLY

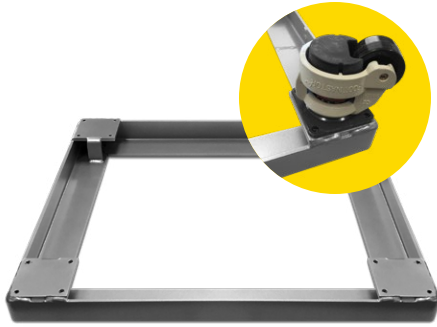

1

Attach casters to base unit. 5K base units (shown) have mounts for 4 casters. 10K base units have mounts for 6 casters. Use 6 casters when stacking 5 or more 10K batteries.

The caster mounts on the base unit are pre-threaded for 1/4" bolts. Hardware is included with the casters.

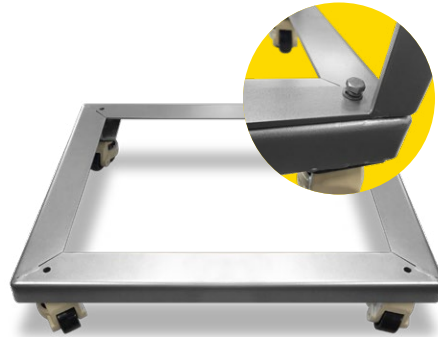

2

Stack flex cabinet shelf unit on top of the base and fasten with 4 bolts. Hardware is included with the batteries.

3

Continue to stack flex cabinet shelf units on your "stack" to reach your desired height. ARK Battery supports stacks of up to 7 batteries.



4

Insert batteries. Lock casters by swiveling the red dial until the brake pad is on the floor and the wheel is lifted up and no longer touches the floor.

Beginning at the bottom, carefully slide batteries into each shelf cavity. Fasten with 4 bolts through the front flanges (see picture). Hardware is included with the batteries.



5

Fasten the top battery to the flex cabinet shelf using the 2 angle brackets (included with battery).



1-888-662-7522 // [arklithium.com](http://arklithium.com) // [info@arklithium.com](mailto:info@arklithium.com)